

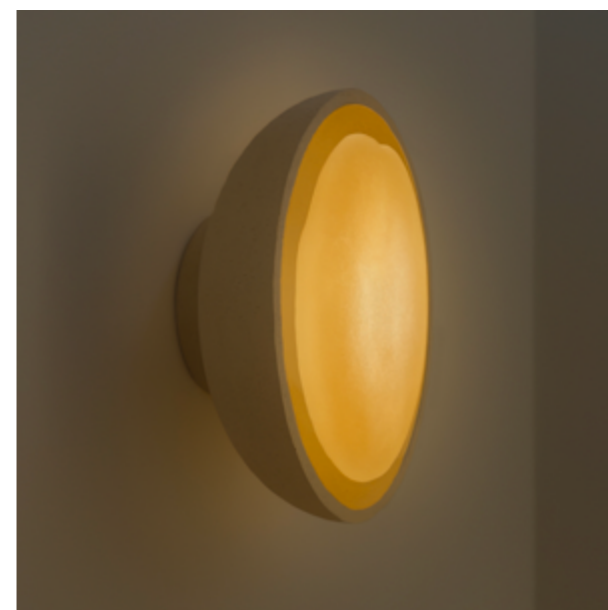

OYO

ROUND SCONCE

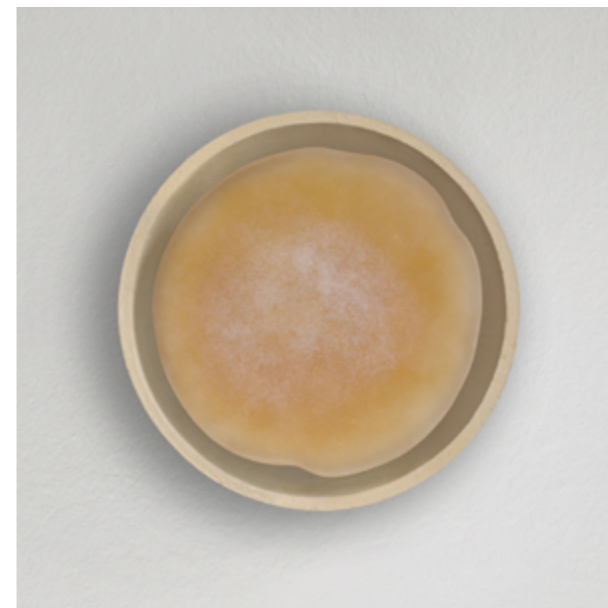

OYO

- ROUND SCONCE

The OYO sconces pay tribute to the alliance of materials and the artisan's touch. Crafted from chamotte plaster, they cradle a frosted glass capsule like a precious jewel, achieving a perfect balance of precision and harmony.

DIMENSIONS

Ø 22 x P 9 cm
Ø 8,7 x 3,5 in

REF. LUM-F002

MATERIALS

Chamotte plaster and textured glass by Claire Pegis
** Handcrafted materials. Slight color variations may occur.*

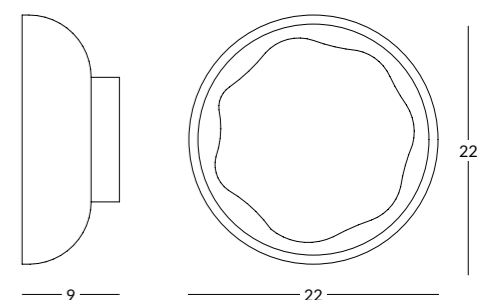



OYO

ROUND SCONCE

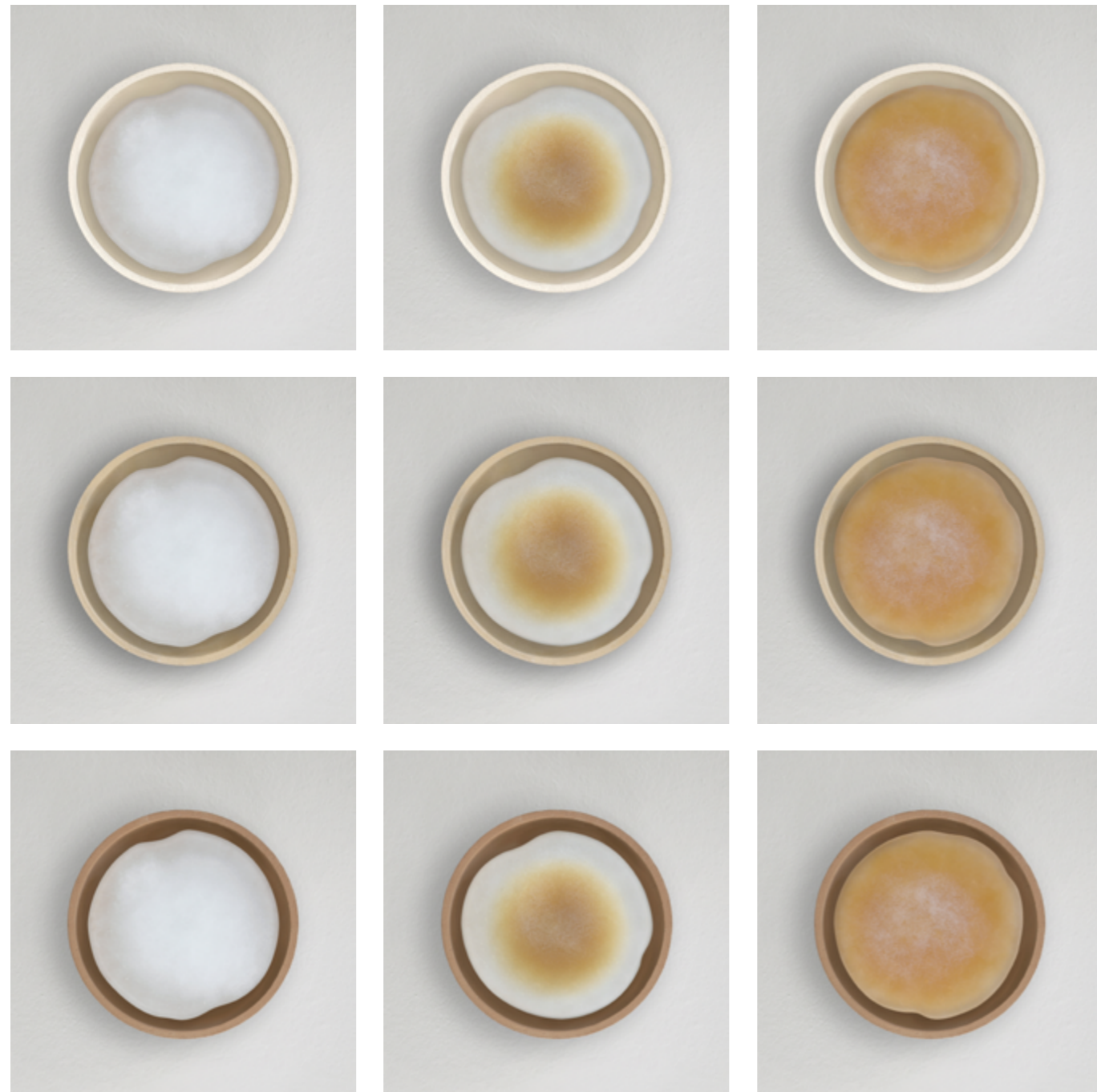

OYO

- ROUND SCONCE

MATERIAL OPTIONS

Chamotte plaster and textured glass
9 combinations available

** Slight color variations may occur between different batches.*

CHAMOTTE PLASTER

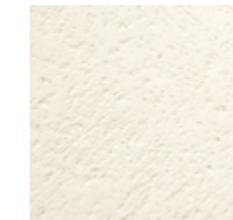

01 WHITE



04 SAND



05 TERRACOTTA

TEXTURED GLASS

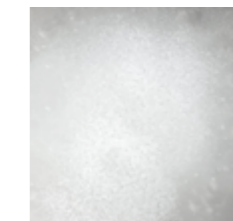

A

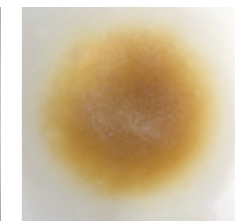

B

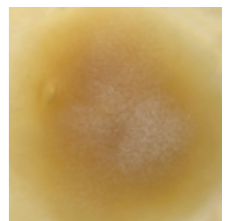

C